

Frame

Kitchens & workbenches

Salvatore Indriolo, 2018



archiproducts
AWARDS
WINNER

archiproducts
AWARDS
WINNER
SUSTAINABILITY



[> go to the outdoor version](#)

Bases / Bases / Bases

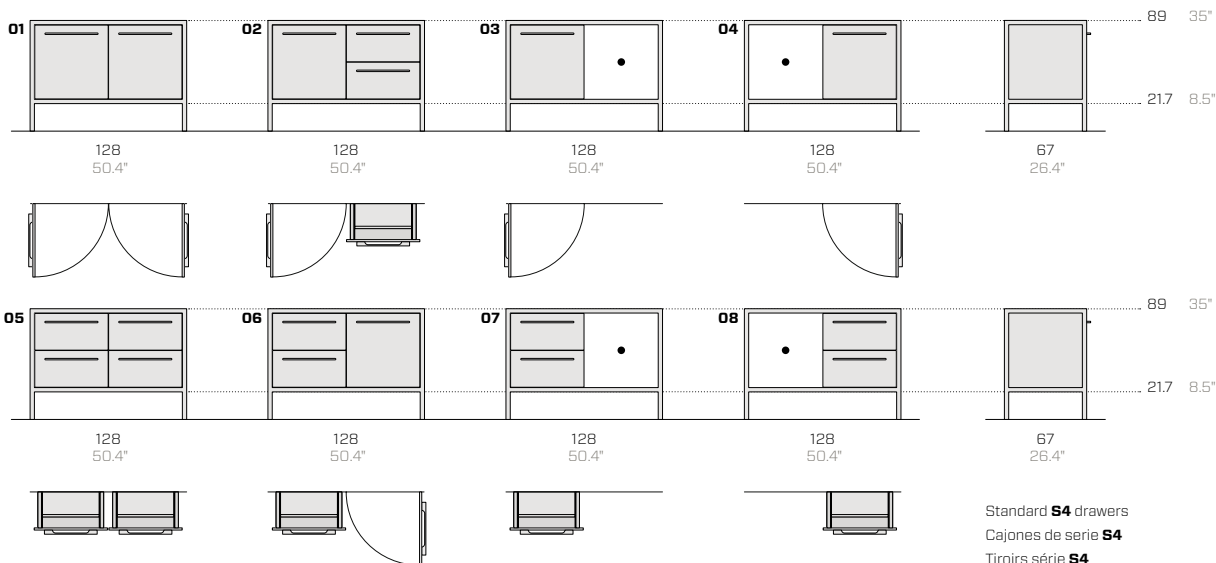

- Compartment for household appliances without Fantin door / Compartimento para electrodomésticos sin puerta Fantin / Compartiment pour électroménager sans porte Fantin

Tops (illustrated with a sink on the left) / Encimeras (mostradas con fregadero a la izquierda) / Plateaux (illustré avec évier à gauche)

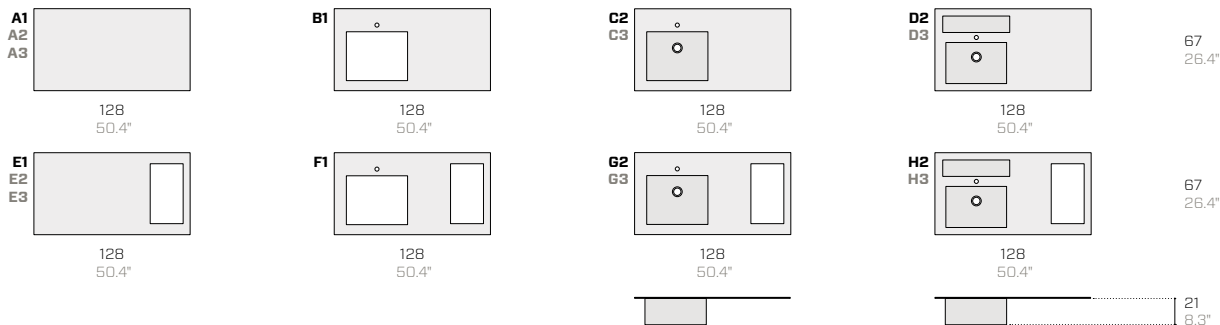

- D, H with SST equipment channel / D, H con canal equipado en inox / D, H avec canal équipé en inox

Useful measurements of the stainless steel top / Dimensiones útiles de la encimera en inox / Dimensions utiles du plateau en inox

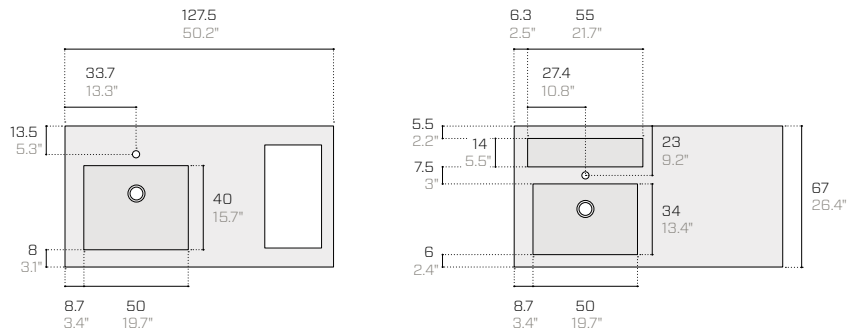

- See the section on the next page for more information.
- Para más información, ver la sección en la página siguiente.
- Pour plus d'informations, voir la section à la page suivante.

Product / Producto / Produit				Packaging / Embalaje / Emballage			
No.	Code	Dimensions (w-d-h)	Weight	Dimensions (w-d-h)	Weight	Vol pkg	
No.	Código	Dimensiones (l-a-a)	Peso	Dimensiones (l-a-a)	Peso	Vol. paq.	
Nº	Code	Dimensions (l-p-h)	Poids	Dimensions (l-p-h)	Poids	Vol. paq.	
		cm	kg	cm	kg	mc	

Bases / Bases / Bases

01	FR85	128 67 89	60	150 80 107	92	1.30
02	FR91D	128 67 89	70	150 80 107	102	1.30
03	FR84S	128 67 89	55	150 80 107	87	1.30
04	FR84D	128 67 89	55	150 80 107	87	1.30
05	FR93	128 67 89	60	150 80 107	112	1.30
06	FR91S	128 67 89	70	150 80 107	102	1.30
07	FR92S	128 67 89	65	150 80 107	97	1.30
08	FR92D	128 67 89	65	150 80 107	97	1.30

Glass top / Encimera en vidrio / Plateau en verre

A1	FRV01A	128 67 0.6	12.5	143 82 12	20	0.20
B1	FRV02A	128 67 0.6	12.0	143 82 12	19	0.20
E1	FRV03A	128 67 0.6	12.0	143 82 12	19	0.20
F1	FRV04A	128 67 0.6	12.5	143 82 12	20	0.20

Satin finish stainless steel top / Encimera en acero inoxidable satinado / Plateau en acier inoxydable satiné

A2	FRX201S	128 67 0.4	27	137 80 21	37	0.30
C2	FRX203S	128 67 0.4	25	137 80 50	35	0.60
D2	FRX221S	128 67 0.4	27	137 80 50	37	0.60
E2	FRX202S	128 67 0.4	23	137 80 21	33	0.30
G2	FRX204S	128 67 0.4	22	137 80 50	32	0.60
H2	FRX222S	128 67 0.4	25	137 80 50	35	0.60

Vintage finish stainless steel top (Barazza) / Encimera en acero inoxidable Vintage (Barazza) / Plateau en acier inoxydable Vintage (Barazza)

A3	FRB41V	128 67 0.4	27	137 80 21	37	0.30
C3	FRB45V	128 67 0.4	25	137 80 50	35	0.60
D3	FRB94V	128 67 0.4	27	137 80 50	37	0.60
E3	FRB43V	128 67 0.4	23	137 80 21	33	0.30
G3	FRB46V	128 67 0.4	22	137 80 50	32	0.60
H3	FRB95V	128 67 0.4	25	137 80 50	35	0.60

Upstand (stainless steel, satin and Vintage finish) / Chapa protectora (acero inox, satinado o vintage) / Dossieret (acier inox, satiné ou Vintage)

-	FRX217S	128 0.4 4	2.5	137 2 10	3	0.10
-	FRB81V	128 0.4 4	2.5	137 2 10	3	0.10

- Scan the QR code to the side to find out more about fitting the hobs in holes in the tops. Fantin shall accept no liability for the assembly and installation of other appliances. If you wish to install other appliances, download the document that is available here and consult it with a qualified fitter.
- Al escanear el código QR que está al lado se puede obtener más información sobre los espacios de las encimeras para instalar las placas. Fantin no asume ninguna responsabilidad por el montaje e instalación de otros electrodomésticos. En este caso, se recomienda consultar con un instalador calificado el documento que se puede descargar aquí.
- Le QR-Code ci-contre vous permet d'en savoir plus sur le perçage des plans de travail pour l'installation des plaques de cuisson. Fantin décline toute responsabilité pour le montage et l'installation d'autres appareils électroménagers. Le cas échéant, il est recommandé de consulter le document téléchargeable ici avec un installateur qualifié.



Bases / Bases / Bases

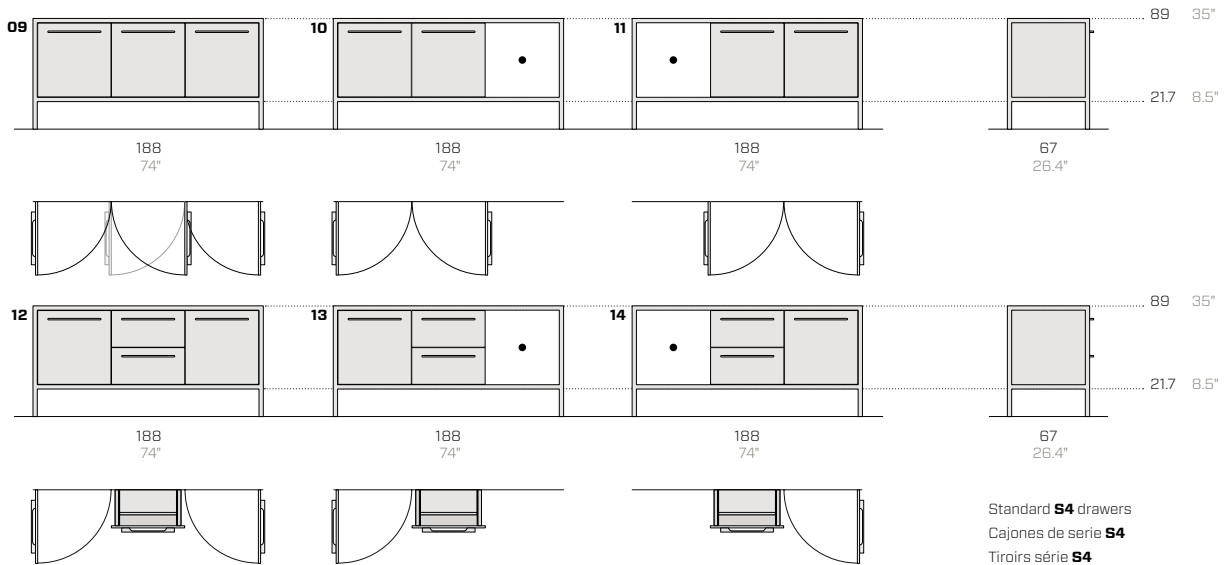

- Compartment for household appliances without Fantin door / Compartimento para electrodomésticos sin puerta Fantin / Compartiment pour électroménager sans porte Fantin

Tops (illustrated with a sink on the left) / Encimeras (mostradas con fregadero a la izquierda) / Plateaux (illustré avec évier à gauche)

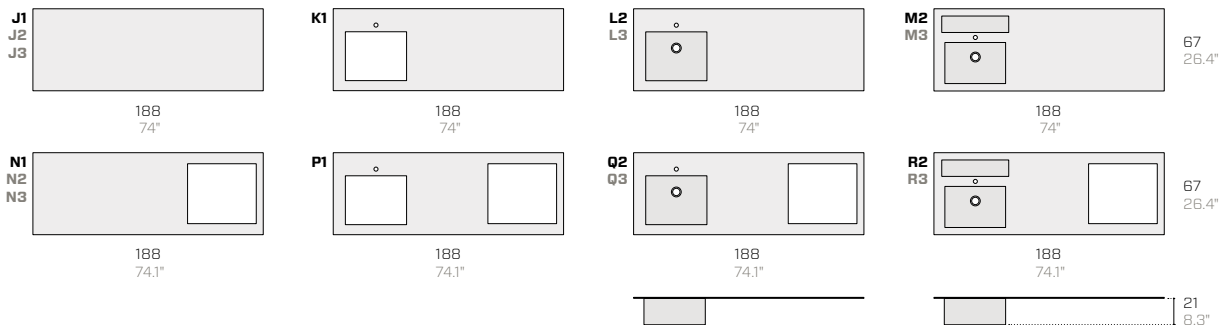

M, R with SST equipment channel / M, R con canal equipado en inox / M, R avec canal équipé en inox

Useful measurements of the stainless steel top / Dimensiones útiles de la encimera en inox / Dimensions utiles du plateau en inox

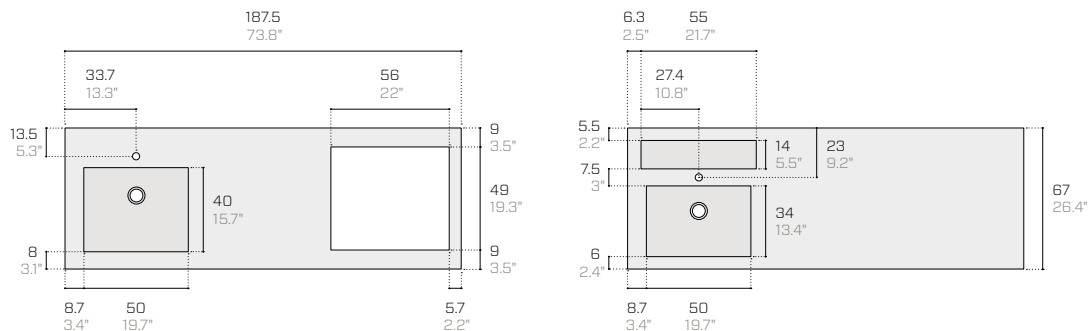

Product / Producto / Produit

Packaging / Embalaje / Emballage

No.	Code	Dimensions (w-d-h)	Weight	Dimensions (w-d-h)	Weight	Vol pkg
No.	Código	Dimensiones (l-a-a)	Peso	Dimensiones (l-a-a)	Peso	Vol. paq.
Nº	Code	Dimensions (l-p-h)	Poids	Dimensions (l-p-h)	Poids	Vol. paq.

Bases / Bases / Bases

09	FR87	188 67 89	92	200 80 107	135	1.80
10	FR86S	188 67 89	87	200 80 107	130	1.80
11	FR86D	188 67 89	87	200 80 107	130	1.80
12	FR83	188 67 89	102	200 80 107	145	1.80
13	FR82S	188 67 89	97	200 80 107	140	1.80
14	FR82D	188 67 89	97	200 80 107	140	1.80

Glass top / Encimera en vidrio / Plateau en verre

J1	FRV05A	188 67 0.6	18.5	203 82 12	29	0.20
K1	FRV11A	188 67 0.6	18.0	203 82 12	28	0.20
N1	FRV07A	188 67 0.6	18.0	203 82 12	28	0.20
P1	FRV12A	188 67 0.6	18.5	203 82 12	29	0.20

Satin finish stainless steel top / Encimera en acero inoxidable satinado / Plateau en acier inoxydable satiné

J2	FRX209S	188 67 0.4	40	197 80 21	50	0.40
L2	FRX211S	188 67 0.4	38	197 80 50	48	0.80
M2	FRX225S	188 67 0.4	39	197 80 50	49	0.80
N2	FRX210S	188 67 0.4	31	197 80 21	41	0.40
Q2	FRX212S	188 67 0.4	30	197 80 50	40	0.80
R2	FRX226S	188 67 0.4	35	197 80 50	45	0.80

Vintage finish stainless steel top (Barazza) / Encimera en acero inoxidable Vintage (Barazza) / Plateau en acier inoxydable Vintage (Barazza)

J3	FRB71V	188 67 0.4	40	197 80 21	50	0.40
L3	FRB75V	188 67 0.4	38	197 80 50	48	0.80
M3	FRB98V	188 67 0.4	39	197 80 50	49	0.80
N3	FRB73V	188 67 0.4	31	197 80 21	41	0.40
Q3	FRB76V	188 67 0.4	30	197 80 50	40	0.80
R3	FRB99V	188 67 0.4	35	197 80 50	45	0.80

Upstand (stainless steel, satin and Vintage finish) / Chapa protectora (acero inox, satinado o vintage) / Dossieret (acier inox, satiné ou Vintage)

-	FRX219S	188 0.4 4	3.5	197 2 10	4	0.10
-	FRB82V	188 0.4 4	3.5	197 2 10	4	0.10

Useful measurements / Dimensiones útiles / Dimensions utiles

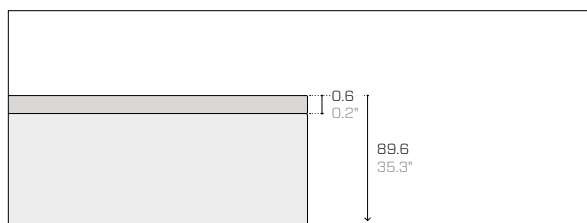

Glass top / Encimera en vidrio / Plateau en verre

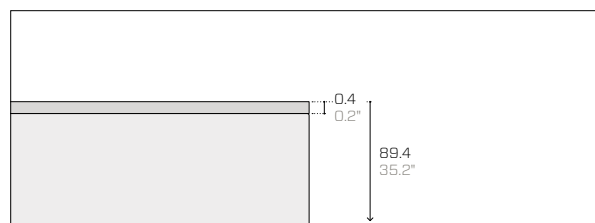

Stainless steel top / Encimera en inox / Plateau en inox

Stainless steel accessories for tops / Accesorios en inox para encimeras / Accessoires en inox pour plateaux

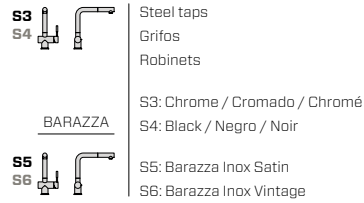
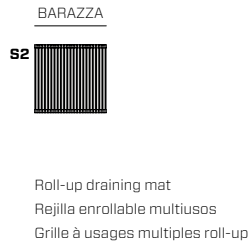
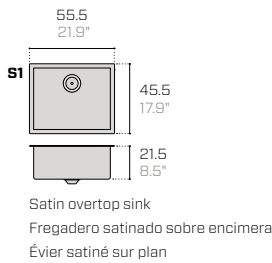

SST accessories for the equipment channel / Accesorios en inox para el canal equipado / Accessoires en inox pour le canal équipé

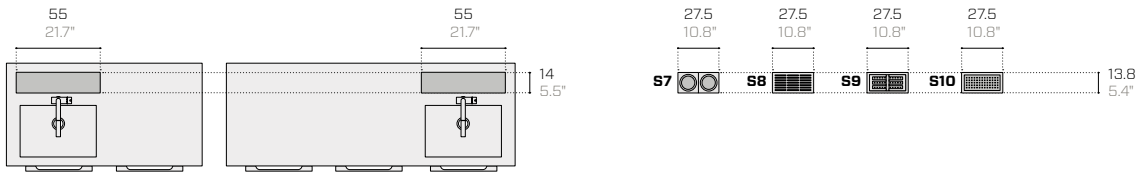

The equipment channel (H 20 cm) can hold a choice of 2 different items. Satin-finish AISI 304 stainless steel channel and accessories.
El canal equipado (H 20 cm) contiene 2 accesorios combinables a elección. Canal y accesorios en acero inoxidable AISI 304 satinado.
Le canal équipé (H 20 cm) contient 2 accessoires qui peuvent être combinés à volonté. Canal et accessoires en acier inoxydable AISI 304 satiné.



Bottle rack (H 17 cm; 2 pieces)
Portabotellas (H 17 cm; 2 elementos)
Porte-bouteilles (H 17 cm; 2 éléments)



Glass drainer (H 1.5 cm)
Escurridor de vasos (H 1.5 cm)
Égouttoir à verres (H 1.5 cm)



Dish drainer (H 7 cm)
Escurridor de platos (H 7 cm)
Égouttoir à vaisselle (H 7 cm)



Sink (H 7 cm)
Bandeja (H 7 cm)
Bac (H 7 cm)

Product / Producto / Produit					Packaging / Embalaje / Emballage					
No.	Code	Dimensions (w-d-h)			Weight	Dimensions (w-d-h)			Weight	Vol pkg
No.	Código	Dimensiones (l-a-a)			Peso	Dimensiones (l-a-a)			Peso	Vol. paq.
N°	Code	Dimensions (l-p-h)			Poids	Dimensions (l-p-h)			Poids	Vol. paq.
		cm			kg	cm			kg	mc
Overtop sink in satin stainless steel / Fregadero sobre encimera en acero inoxidable satinado / Évier sur plan en acier inoxydable satiné										
S1	FRB20S	55.5	45.5	21.5	6.5	59.5	49.5	27	8.5	0.10
Roll-up draining mat / Rejilla enrollable multiusos / Grille à usages multiples / roll-up										
S2	FRB11	47	45	1	1	50	8	8	1	0.10
Steel taps / Grifos / Robinets										
S3	FRB10C	13	26	27	3	59	25	10	4	0.10
S4	FRB10N	13	26	27	3	59	25	10	4	0.10
S5	FRB10S	13	26	27	3	59	25	10	4	0.10
S6	FRB10V	13	26	27	3	59	25	10	4	0.10
SST accessories for the equipment channel / Accesorios en inox para el canal equipado / Accessoires en inox pour le canal équipé										
S7	FRB13S	27.5	13.8	17.0	1.0	30	46	12	1.2	0.10
S8	FRB14S	27.5	13.8	1.5	0.3	34	18	4	0.5	0.10
S9	FRB15S	27.5	13.8	7.0	1.3	30	23	12	1.5	0.10
S10	FRB16S	27.5	13.8	7.0	1.0	30	23	12	1.2	0.10
Back panel for freestanding kitchen / Fondo para cocina independiente / Dos pour cuisine indépendante										
-	FRK01S1	120	3	60	6	124	64	7	7	0.10
-	FRK02S2	180	3	60	9	184	64	7	10	0.10
Floor attachment cover kit / Kit de cubierta de conexiones al suelo / Jeu de caches pour raccordements au sol										
-	FRK03A1	60	20	25	3	62	22	27	5	0.10



Drawer kits / Kit de cajones / Jeu de tiroirs

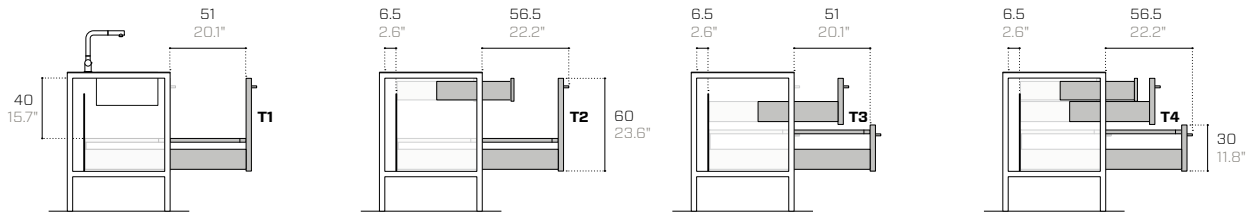

T1
Kit 1 large drawer
Kit 1 cajón grande
Jeu de 1 grand tiroir

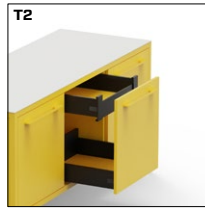

T2
Kit 1 large drawer + 1 inner drawer
Kit 1 cajón grande + 1 cajón interior
Jeu de 1 grand tiroir + 1 tiroir intérieur

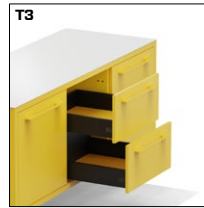

T3
Kit 2 drawers
Kit 2 cajones
Jeu de 2 tiroirs

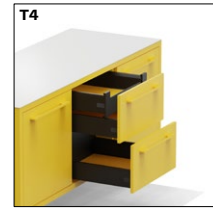

T4
Kit 2 drawers + 1 inner drawer
Kit 2 cajones + 1 cajón interior
Jeu de 2 tiroirs + 1 tiroir intérieur

Wheel kit with colour-matching discs / Kit de ruedas con discos a juego / Jeu de roulettes avec jantes assorties

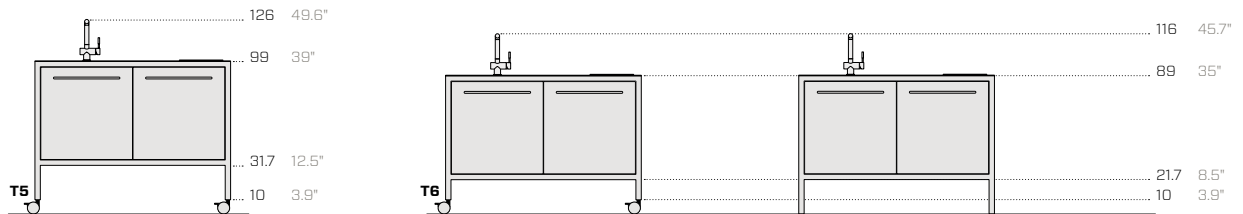

Kitchen height (with wheels)
Altura de la cocina (con ruedas)
Hauteur du cuisine (avec roulettes)

Kitchen with wheel kit and resized legs (same overall height as the kitchen without wheel kit)
Cocina con kit de ruedas y patas redimensionadas (misma altura total que la cocina sin kit de ruedas)
Cuisine avec jeu de roulettes et pieds redimensionnés (même hauteur totale que la cuisine sans jeu de roulettes)



T5

Product / Producto / Produit

Packaging / Embalaje / Emballage

No.	Code	Dimensions (w-d-h)	Weight	Dimensions (w-d-h)	Weight	Vol pkg
No.	Código	Dimensiones (l-a-a)	Peso	Dimensiones (l-a-a)	Peso	Vol. paq.
Nº	Code	Dimensions (l-p-h)	Poids	Dimensions (l-p-h)	Poids	Vol. paq.
		cm	kg	cm	kg	mc

Drawer kits (surcharge on the door price) / Kit de cajones (recargo en el precio de la puerta) / Jeu de tiroirs (supplément sur le prix de la porte)

T1	FRK21C1	60 55 60	13	63 58 63	14	0.30
T2	FRK20C2	60 55 60	18	63 58 63	19	0.30
T3	FRK22C2	60 55 60	15	63 58 63	16	0.30
T4	FRK23C3	60 55 60	20	63 58 63	21	0.30

Aluminum cutlery dividers / Separadores de cubiertos de aluminio / Séparateurs de couverts en aluminium

-	FRK14DP	48 8 5	1	50 10 6	1	0.10
---	---------	--------	---	---------	---	------

Waste separation systems / Cubos de basura para separación de residuos / Poubelles de séparation des déchets

-	FRK61DIF	44 29 22	3	50 10 6	4	0.10
-	FRK60DIF	46 30 30	2	50 10 6	3	0.10

Additional shelf / Estante adicional / Étagère supplémentaire

-	FRK10R1	57 46 2	3	50 10 6	3	0.10
---	---------	---------	---	---------	---	------

Wheel kit with colour-matching discs / Kit de ruedas con discos a juego / Jeu de roulettes avec jantes assorties

T5	FRK31R8	8 3.5 10	2	20 10 10	3	0.10
T6	FRK33R8	8 3.5 10	2	20 10 10	3	0.10

Other useful measurements / Otras dimensiones útiles / Autres dimensions utiles

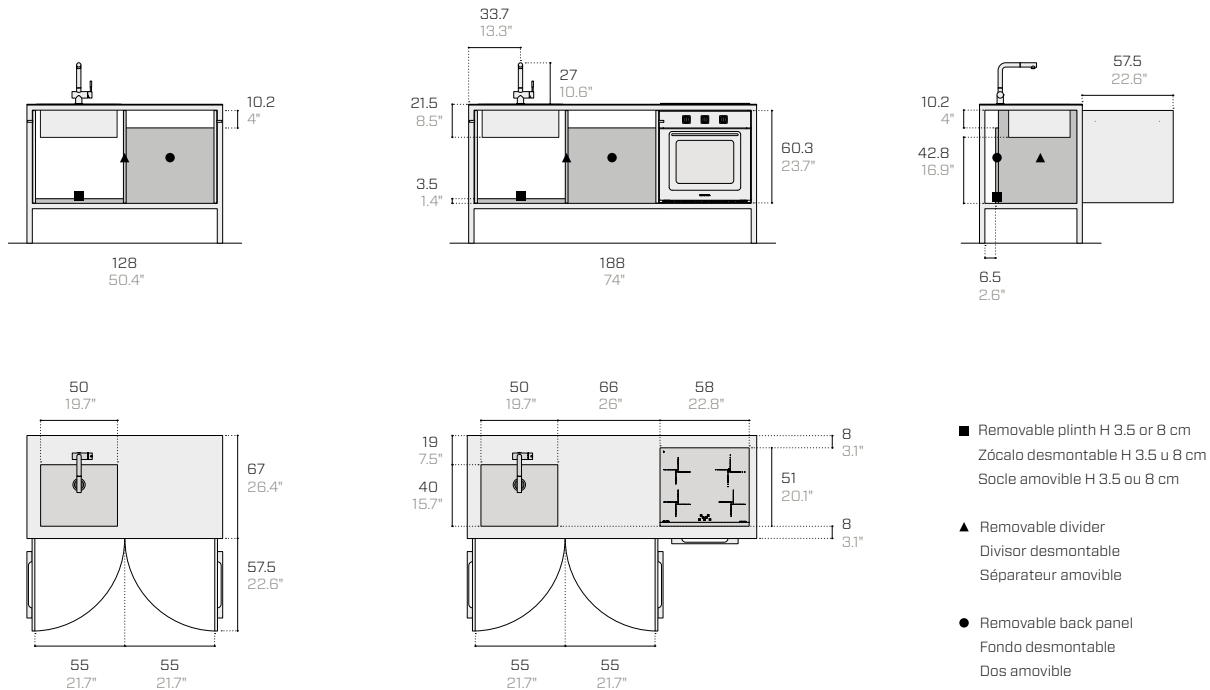

Shelf / Estante / Étagère

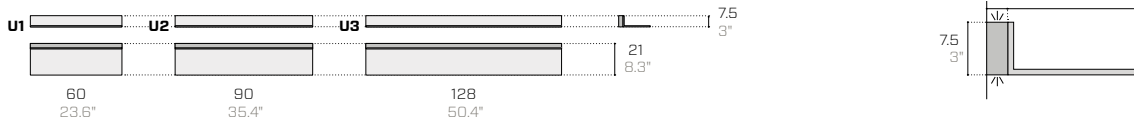

U3 compatible with 3000K LED bar / U3 compatible con barra LED 3000K / U3 compatible avec barre LED 3000K

Open compartment / Compartimiento abierto / Niche ouverte

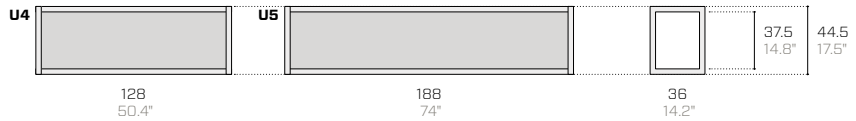
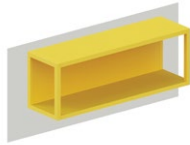

Wall panelling / Panel de pared / Panneau mural

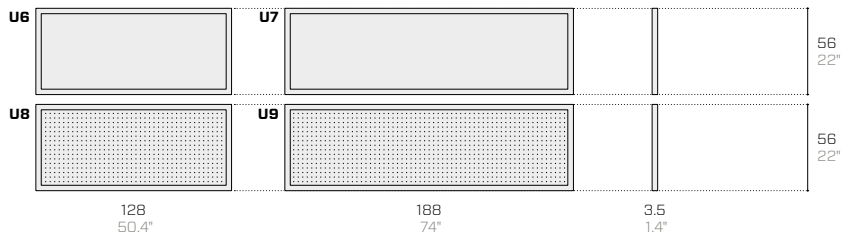

Wall panelling with shelf / Panel de pared con estante / Panneau mural avec étagère

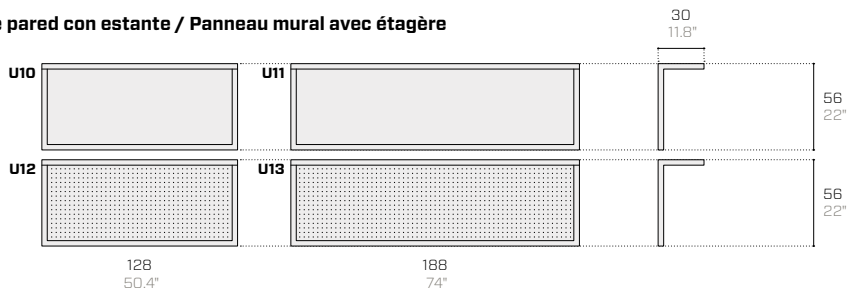

Items compatible with 3000K LED bar / Modelos compatibles con barra LED 3000K / Modèles compatibles avec barre LED 3000K

Useful measurements / Dimensiones útiles / Dimensions utiles

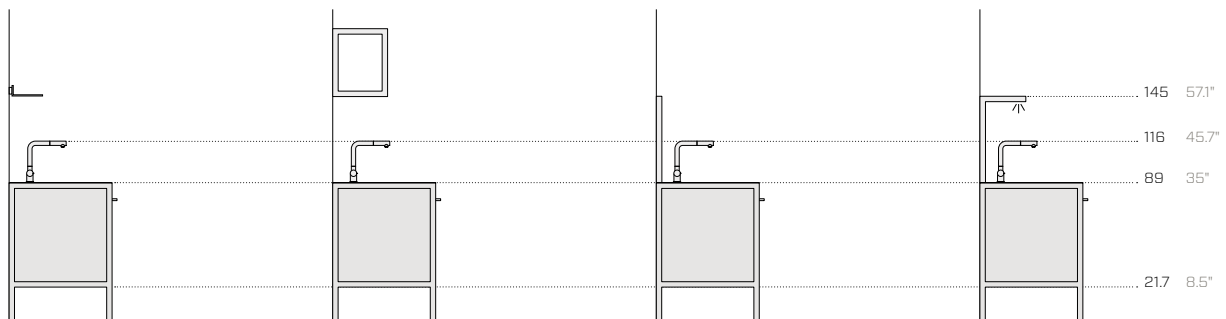

U1 / U2 / U3
Free scope for wall mounting
Fijación libre a la pared
Fixation libre au mur

U4 / U5
Free scope for wall mounting
Fijación libre a la pared
Fixation libre au mur

U6 / U7 / U8 / U9
Free scope for wall mounting
Fijación libre a la pared
Fixation libre au mur

U10 / U11 / U12 / U13 *
Attachment to kitchen and wall
Fijación a la cocina y a la pared
Fixation à la cuisine et au mur

* U10 / U11 / U12 / U13 - For glass tops, attachment to the wall only / Para encimeras en vidrio, fijación sólo a la pared / Pour plateaux en verre, montage mural uniquement

Product / Producto / Produit						Packaging / Embalaje / Emballage					
No.	Code	Dimensions (w-d-h)			Weight	Max capacity	Dimensions (w-d-h)			Weight	Vol pkg
No.	Código	Dimensiones (l-a-a)			Peso	Capacidad max	Dimensiones (l-a-a)			Peso	Vol. paq.
Nº	Code	Dimensions (l-p-h)			Poids	Charge maxi	Dimensions (l-p-h)			Poids	Vol. paq.
		cm			kg	kg	cm			kg	mc
Shelf / Estante / Étagère											
U1	FRM13	60	21	7.5	4.0	6	70	30	20	5.0	0.10
U2	FRM14	90	21	7.5	6.0	9	100	30	20	7.0	0.10
U3	FRM15	128	21	7.5	8.5	12	140	30	20	9.5	0.10
Open compartment / Compartimiento abierto / Niche ouverte											
U4	FRM11	128	36	44.5	30	30	140	40	10	32	0.10
-	FRM16	158	36	44.5	38	38	170	40	10	40	0.10
U5	FRM12	188	36	44.5	45	45	200	40	10	47	0.10
Solid sheet metal wall panelling / Panel de pared de chapa sólida / Panneau mural en tôle pleine											
U6	FRM07	128	3.5	56	14	-	140	60	10	17	0.10
U7	FRM08	188	3.5	56	20	-	200	60	10	23	0.20
Perforated sheet metal wall panelling / Panel de pared de chapa perforada / Panneau mural en tôle perforée											
U8	FRM09	128	3.5	56	13	-	140	60	10	16	0.10
U9	FRM10	188	3.5	56	19	-	200	60	10	22	0.20
Solid sheet metal wall panelling with shelf / Panel de pared de chapa sólida con estante / Panneau mural en tôle pleine avec étagère											
U10	FRM01	128	30	56	18	30	140	60	40	21	0.40
U11	FRM02	188	30	56	27	45	200	60	40	31	0.50
Perforated sheet metal wall panelling with shelf / Panel de pared de chapa perforada con estante / Panneau mural en tôle perforée avec étagère											
U12	FRM05	128	30	56	17	30	140	60	40	20	0.40
U13	FRM06	188	30	56	26	45	200	60	40	30	0.30
LED bar 3000K (10W per meter) / Barra LED 3000K (10W por metro) / Barre LED 3000K (10W par mètre)											
-	FRS128L3	121	3.5	3.5	0.2	-	124	6.5	6.5	0.2	0.10
-	FRS188L3	181	3.5	3.5	0.3	-	184	6.5	6.5	0.3	0.10
24V-20W Power supply kit / Kit con fuente de alimentación 24V-20W / Kit avec alimentation 24V-20W											
-	FRSK1LPS	-	-	-	0.2	-	-	-	-	0.2	-
Magnetic dimmer switch / Regulador magnético / Variateur magnétique											
-	FRSK6D	2	7	2	0.2	-	5	10	5	0.3	0.10
Kit of 5 hooks / Kit de 5 ganchos / Lot de 5 crochets											
-	FRK29GA	-	-	-	0.1	-	-	-	-	0.1	-
Kit of 5 magnets / Kit de 5 imanes / Lot de 5 aimants											
-	FRK28CA	-	-	-	0.1	-	-	-	-	0.1	-

Hobs / Placas de cocción / Plaques de cuisson

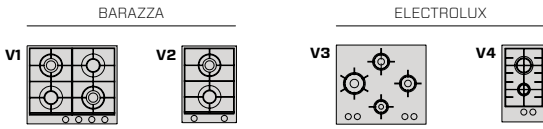

Gas hobs
Placas de gas
Plaques de cuisson à gaz

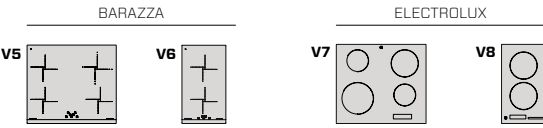

Electric induction hobs
Placas de inducción eléctricas
Plaques électriques à induction

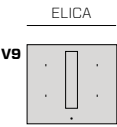

Electric induction hob with integrated filtering hood
Placa de inducción eléctrica con campana filtrante integrada
Plaque électrique à induction avec hotte filtrante intégrée

Shelf with integrated Falmecc hood / Estante con campana Falmecc integrada / Étagère avec hotte Falmecc intégrée

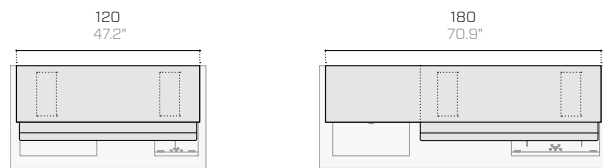
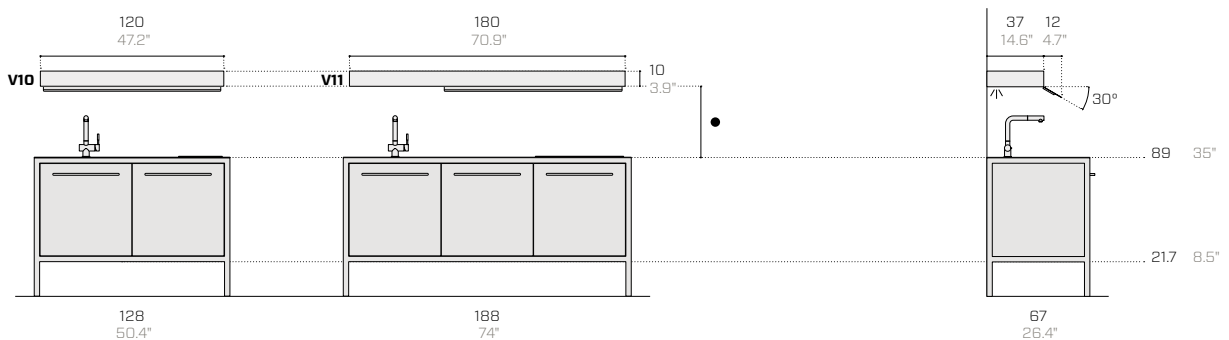

- It must be installed at least 62 cm above gas hobs and 52 cm above induction hobs. On the shelf with a width of 180 cm, the extractor can be positioned on the left or the right.
- La instalación mínima es de 62 cm sobre placas de gas y 52 cm sobre placas de inducción. En el estante L180 cm, la extracción se puede colocar a la izquierda o a la derecha.
- La hauteur d'installation minimale est de 62 cm au-dessus des plaques de cuisson à gaz et de 52 cm au-dessus des plaques à induction. Pour l'étagère de 180 cm de long, l'aspiration peut être positionnée à gauche ou à droite.

Product / Producto / Produit

Packaging / Embalaje / Emballage

No.	Code	Brand code	Dimensions (w-d-h)			Weight	Dimensions (w-d-h)			Weight
No.	Código	Código de marca	Dimensiones (l-a-a)			Peso	Dimensiones (l-a-a)			Peso
N°	Code	Code marque	Dimensions (l-p-h)			Poids	Dimensions (l-p-h)			Poids
			cm			kg	cm			kg

Gas hobs / Placas de gas / Plaques de cuisson à gaz

V1	FRE32	1PBF64	58.5	51.0	9.5	12	68	58	16.5	15
V2	FRE31	1PBF2	36.0	51.0	10.0	6	44	58	18.5	10
V3	FRE54	KGU643723Z	59.5	52.5	6.5	12	71	62	16.0	14
V4	FRE21	EGG3222N	29.0	51.0	6.5	5	48	62	15.0	7

Electric induction hobs / Placas de inducción eléctricas / Plaques électriques à induction

V5	FRB05-F4	1PIDC60N	58.0	51.0	5.4	8	67	60	12.5	10
V6	FRB06-F2	1PIDC30N	28.5	50.5	5.4	5	39	60	13.0	6
V7	FRE48	KIB60424CK	59.0	52.0	6.5	12	80	60	15.0	14
V8	FRE02	LIT30231C	27.0	49.0	6.5	6	48	60	15.0	8

Aspirating induction hob (w. installation kit) / Placa de inducción extractora (con kit de instalación) / Plaque à induction aspirante (avec kit d'installation)

V9	FRE37	PRF0167053	60	51.5	26	20	80	60	30	22
----	-------	------------	----	------	----	----	----	----	----	----

Kit for aspirating induction hob / Kit para placa de inducción extractora / Kit pour plaque à induction aspirante

xV9	FRE37-KIT	-	-	-	-	2	-	-	-	2
-----	-----------	---	---	---	---	---	---	---	---	---

Shelf with integrated Falmecc hood / Estante con campana Falmecc integrada / Étagère avec hotte Falmecc intégrée

V10	FR97	-	120.5	38	10.5	30	130	47	40	35
V11	FR98	-	180.5	38	10.5	39	130	47	60	45

Frame kitchens are compatible with Miele appliances

Las cocinas Frame son compatibles con los electrodomésticos Miele

Les cuisines Frame sont compatibles avec les appareils Miele

Examples of compositions / Ejemplos de composiciones / Exemples de compositions

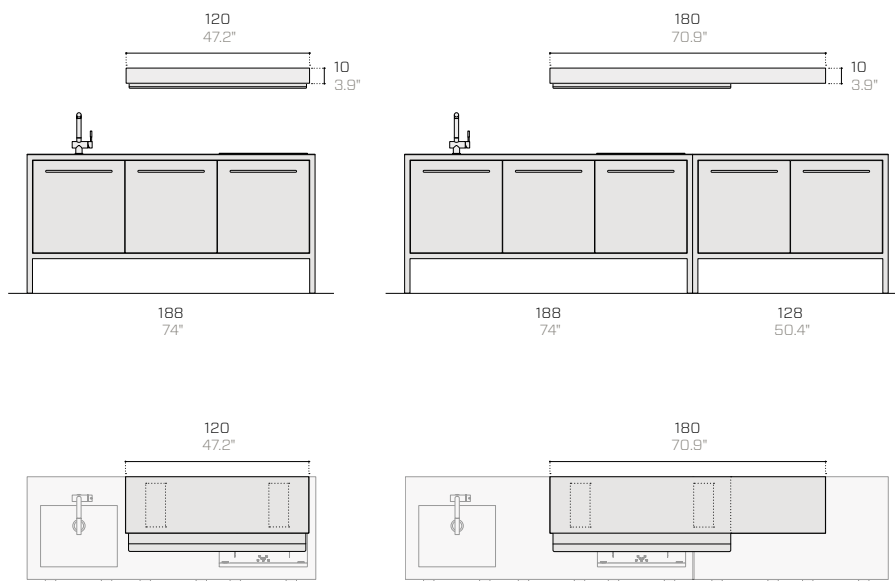

Custom width on request (with 60 or 90 cm pitch and with maximum width of the front cover - in the same color as the kitchen frame - of 220 cm).

Ancho a medida bajo pedido (con paso de 60 o 90 cm y con ancho máximo del frontal - del mismo color que la estructura de la cocina - de 220 cm).

Largeur sur mesure sur demande (au pas de 60 ou 90 cm et avec largeur maximale de la façade - de la même couleur que le cadre de la cuisine - de 220 cm).

Integrated appliances / Electrodomésticos empotrados / Appareils encastrables

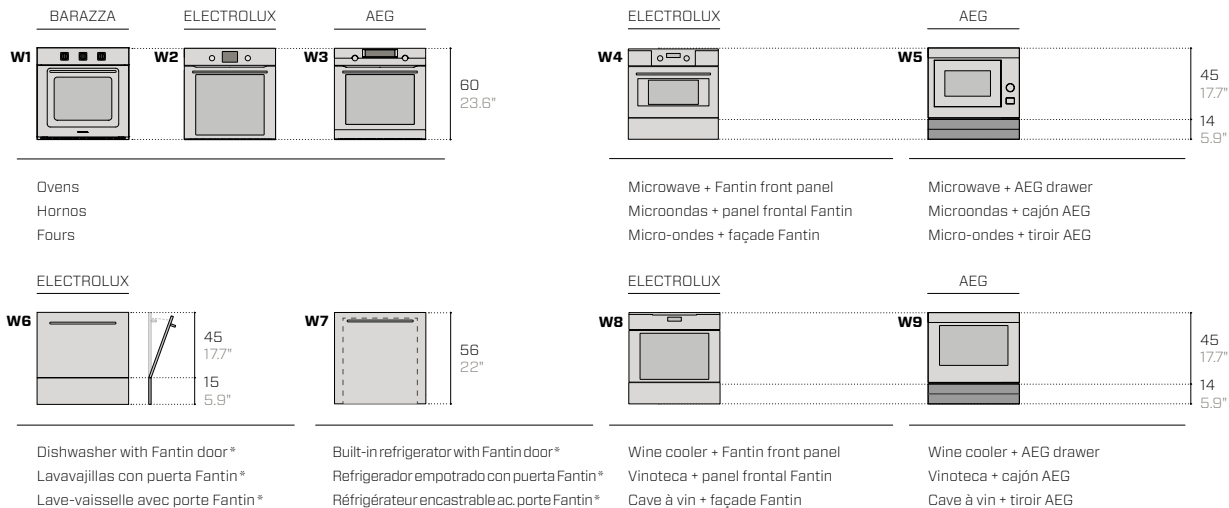

*Replacing an existing door / Para reemplazar una puerta existente / Pour remplacer une porte existante

Freestanding appliance kits / Kits para electrodomésticos en el suelo / Kits pour appareils électroménagers à poser au sol

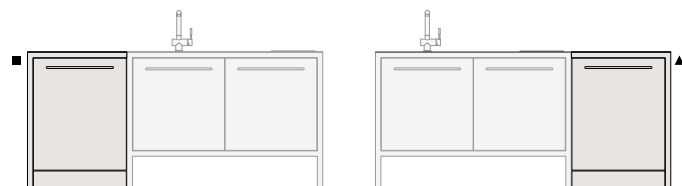
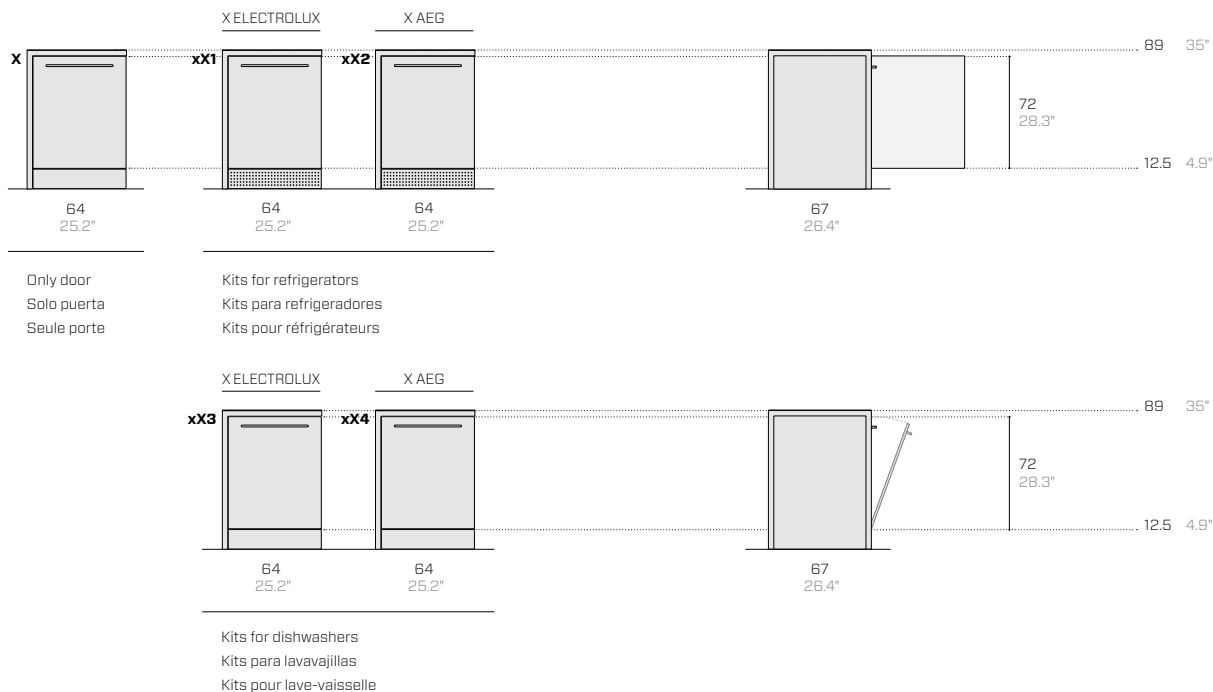

The kits can be placed on either the left [●] or the right [▲].
 Los kits se pueden colocar tanto a la izquierda [●] como a la derecha [▲].
 Les kits peuvent être positionné à gauche [●] comme à droite [▲].

Product / Producto / Produit

Packaging / Embalaje / Emballage

No.	Code	Brand code	Dimensions (w-d-h)	Weight	Dimensions (w-d-h)	Weight
No.	Código	Código de marca	Dimensiones (l-a-a)	Peso	Dimensiones (l-a-a)	Peso
Nº	Code	Code marque	Dimensions (l-p-h)	Poids	Dimensions (l-p-h)	Poids
			cm	kg	cm	kg

Integrated appliances (w. installation kit) / Electrodomésticos empotrados (con kit de instalación) / Appareils encastrables (avec kit d'installation)

W1	FRB02V-FV	1FUAM	60 61 60	35	64 64 68	39
W2	FRE03	KOFFP46TX	60 60 55	33	64 64 68	37
W3	FRE49	BEK435E21M	60 60 55	33	64 64 68	37
W4	FRE46	KVMDE46X	60 56 60	40	66 54 53	31
W5	FRE11	MBE2658DEM	60 53 60	28	66 54 53	31
W6	FRE36	ESL2500RO	56 55 45	38	60 56 51	40
W7	FRE45	C600S	49 47 56	25	60 56 51	27
W8	FRE47	KBW5X	60 56 60	34	66 54 53	31
W9	FRE13	KWK884520M	60 53 60	28	66 54 53	31

Kits for integrated appliances / Kits para electrodomésticos empotrados / Kit pour appareils encastrables

xW1	FRB02V-KIT	-	2.0 7 58.0	2	10 10 84	3
xW2	FRE03-KIT	-	2.0 7 58.0	2	10 10 84	3
xW3	FRE49-KIT	-	2.0 7 58.0	2	10 10 84	3
xW4	FRE46-KIT	-	59.7 52 14.0	5	10 10 84	6
xW5	FRE11-KIT	-	2.0 7 58.0	2	10 10 84	3
xW6	FRE36-KIT	-	59.7 52 59.7	8	10 10 84	9
xW7	FRE45-KIT	-	59.7 10 59.7	7	10 10 84	8
xW8	FRE47-KIT	-	59.7 52 14.0	5	10 10 84	6
xW9	FRE13-KIT	-	2.0 7 58.0	2	10 10 84	3

Freestanding additional door kit / Kit puerta adicional de suelo / Kit porte supplémentaire pour pose au sol

X	FRK13ET	-	64 67 89	18	67 70 92	23
----------	---------	---	----------	----	----------	----

Freestanding appliances (no kit) / Electrodomésticos en el suelo (sin kit) / Appareils électroménagers à poser au sol (sans kit)

[X1]	FRE55	KSB2AE82S	56.0 55 82	31	63 63 87	33
[X2]	FRE56	QSF6I82EF	56.0 55 82	35	63 63 87	37
[X3]	FRE43	KESC8300L	59.5 55 82	37	63 63 87	38
[X4]	FRE57	FSK73617Z	59.5 55 82	37	63 63 87	38

Freestanding appliance kits / Kit para electrodomésticos en el suelo / Kit pour appareils électroménagers à poser au sol

xx1	FRE55-KIT	-	64 67 89	18	67 70 92	23
xx2	FRE41-KIT	-	64 67 89	18	67 70 92	23
xx3	FRE56-KIT	-	64 67 89	18	67 70 92	23
xx4	FRE57-KIT	-	64 67 89	18	67 70 92	23

• Scan the QR code to find out more about the assembly and installation kits for the appliances in the table (included in the prices of the appliances themselves or available for purchase separately). Fantin shall accept no liability for the assembly and installation of other appliances. If you wish to install other appliances, download the document that is available here and consult it with a qualified fitter. Frame Kitchen are compatible with Miele appliances whose dimensions match the details given in the document that can be downloaded by scanning the QR code. For appliances of this kind, Fantin is prepared to consider making an assembly kit, once it has been given the specific technical installation guide.

• Al escanear el código QR que está al lado, es posible conocer más sobre los kits de montaje y la instalación de los electrodomésticos de la tabla (incluidos en los precios de los propios electrodomésticos o que se pueden comprar por separado). Fantin no asume ninguna responsabilidad por el montaje e instalación de otros electrodomésticos. En este caso, se recomienda consultar con un instalador calificado el documento que se puede descargar aquí. Frame Kitchen es compatible con la instalación de electrodomésticos Miele que tengan las dimensiones adecuadas, indicadas en el documento que se puede descargar desde el código QR. Para ello, Fantin está disponible para evaluar la producción de un kit de montaje, una vez que haya recibido la ficha técnica específica de instalación.

• Le QR-Code ci-contre vous permet d'en savoir plus sur les KITS de montage et d'installation des appareils électroménagers figurant dans le tableau (inclus dans le prix des appareils électroménagers ou pouvant être achetés séparément). Fantin décline toute responsabilité pour le montage et l'installation d'autres appareils électroménagers. Le cas échéant, il est recommandé de consulter le document - téléchargeable ici - avec un installateur qualifié. Frame Kitchen peut recevoir des appareils électroménagers de la marque Miele pour autant que leurs dimensions correspondent à celles indiquées dans le document téléchargeable à partir du QR code. Pour ces appareils, Fantin est prêt à évaluer la production d'un kit de montage, après réception de la fiche technique d'installation spécifique.



Bases / Bases / Bases

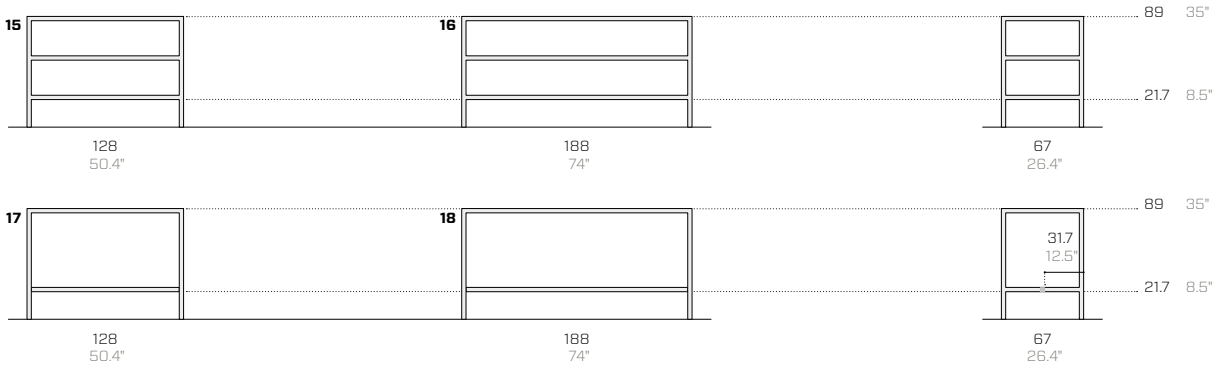

Tops / Encimeras / Plateaux



Accessories and details / Accesorios y detalles / Accessoires et détails

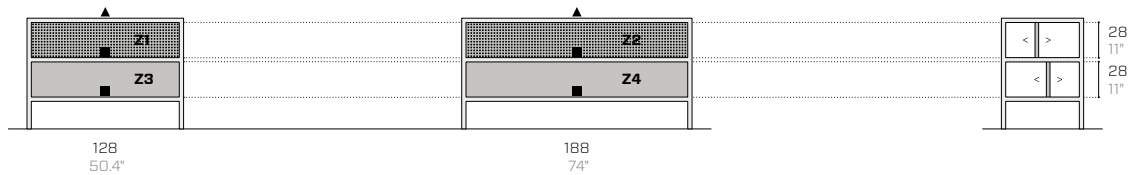

▲ Top (available in 4 versions)
Encimera (disponible en 4 versiones)
Plateau (disponible en 4 versions)

■ Lower shelves in metal (not replaceable)
Estantes inferiores metálicos (no reemplazables)
Étagères inférieures en métal (non remplaçables)

Z. Full or perforated separator (freely positionable)
Separador sólido o perforado (libremente posicionable)
Séparateur plein ou perforé (librement positionnable)



Product / Producto / Produit

Packaging / Embalaje / Emballage

No.	Code	Dimensions (w-d-h)	Weight	Dimensions (w-d-h)	Weight	Vol pkg
No.	Código	Dimensiones (l-a-a)	Peso	Dimensiones (l-a-a)	Peso	Vol. paq.
N°	Code	Dimensions (l-p-h)	Poids	Dimensions (l-p-h)	Poids	Vol. paq.
:	:	cm	kg	cm	kg	mc

Bases / Bases / Bases

15	FR88	128 67 89	60	150 80 107	103	1.30
16	FR81	188 67 89	75	200 80 107	118	1.80
17	FR95	128 67 89	32	150 80 107	75	1.30
18	FR96	188 67 89	38	200 80 107	81	1.80

Metal top / Encimera en metal / Plateau en métal

Y1	FR88TOPS	128 67 0.3	16	132 71 10	20	0.10
Y2	FR81TOPS	188 67 0.3	23	192 71 10	28	0.20

Food-grade tops are found at the Finishes section / Encimeras aptas para alimentos en la sección de Acabados / Plateaux de qualité alimentaire dans la section Finitions

Glass top / Encimera en vidrio / Plateau en verre

Y3	FRV01A	128 67 0.6	12.5	143 82 12	20	0.20
Y4	FRV05A	188 67 0.6	18.5	203 82 12	29	0.20

Satin finish stainless steel top / Encimera en acero inoxidable satinado / Plateau en acier inoxydable satiné

Y5	FRX201S	128 67 0.4	28	137 80 21	50	0.30
Y6	FRX209S	188 67 0.4	40	197 80 21	50	0.40

Vintage finish stainless steel top (Barazza) / Encimera en acero inoxidable Vintage (Barazza) / Plateau en acier inoxydable Vintage (Barazza)

Y7	FRB41V	128 67 0.4	28	137 80 21	50	0.30
Y8	FRB71V	188 67 0.4	40	197 80 21	50	0.40

Perforated separators / Separadores perforados / Séparateurs perforés

Z1	FRK05SF	128 28 4	4	132 32 5	9	0.10
Z2	FRK06SF	188 28 4	5	192 32 5	10	0.10

Full separators / Separadores sólidos / Séparateurs pleins

Z3	FRK07SC	128 28 4	5	132 32 5	9	0.10
Z4	FRK08SC	188 28 4	6	192 32 5	10	0.10

Wheel kit with colour-matching discs / Kit de ruedas con discos de colores a juego / Jeu de roulettes avec jantes de couleur assortie

-	FRK31R8	8 3.5 10	2	20 10 10	3	0.10
-	FRK33R8	8 3.5 10	2	20 10 10	3	0.10

Useful measurements / Dimensiones útiles / Dimensions utiles

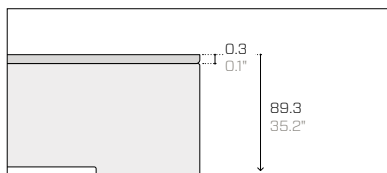

Metal top / Encimera en metal / Plateau en métal

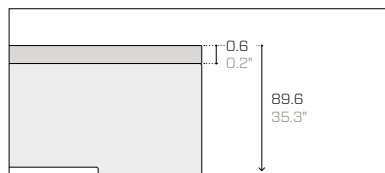

Glass top / Encimera en vidrio / Plateau en verre

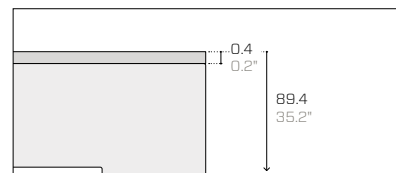

Stainless steel top / Encimera en inox / Plateau en inox

Metal essentials

	<p>01.18 Black (RAL 9005) Negro / Noir --- EM ▲</p>		<p>08.20 Rose quartz Rosa cuarzo / Quartz rose --- EM ▲■</p>		<p>15.19 Forest green (RAL 6007) Verde bosque / Verte forêt --- EM ▲●</p>
	<p>02.18 Anthracite (RAL 7021) Antracita / Anthracite --- EM ▲●■</p>		<p>09.24 Terracotta (RAL 8004) Terracota / Terre cuite --- EM ▲●■</p>		<p>16.24 Cement (RAL 7033) Cemento / Ciment --- EM ▲●■</p>
	<p>03.18 Fantin grey Fantin gris / Gris Fantin --- EM ▲●■</p>		<p>10.21 Flame red (RAL 3000) Rojo Fuego / Rouge feu --- EM ▲</p>		<p>17.24 Slate (RAL 7031) Pizarra / Ardoise --- EM ▲●■</p>
	<p>04.18 Light grey (RAL 7035) Gris claro / Gris clair --- EM ▲●■</p>		<p>11.21 Melon yellow (RAL 1028) Amarillo melón / Jaune melon --- EM ▲●</p>		<p>18.21 Dusty blue (RAL 5014) Azul polvoriento / Bleu poussiéreux --- EM ▲■</p>
	<p>05.19 Cloud grey Gris nube / Gris nuage --- EM ▲■</p>		<p>12.19 Zinc yellow (RAL 1018) Amarillo zinc / Jaune de zinc --- EM ▲■</p>		<p>19.18 Gentian blue (RAL 5010) Azul genciana / Bleu gentiane --- EM ▲●</p>
	<p>06.18 White (RAL 9016) Blanco / Blanc --- EM ▲■</p>		<p>13.21 Pastel green (RAL 6019) Verde pastel / Vert pastel --- EM ▲●■</p>		<p>20.19 Steel blue (RAL 5011) Azul acero / Bleu acier --- EM ▲</p>
	<p>07.21 Milk white (RAL 9001) Blanco leche / Blanc de lait --- EM ▲●■</p>		<p>14.18 Sage green (RAL 6021) Verde salvia / Vert sauge --- EM ▲●■</p>		<p>21.21 Coffee brown (RAL 8019) Marrón café / Marron café --- EM ▲■</p>

Metal design

Metallic



61.24
Pale gold
Oro claro / Or clair

EM ▲■



62.24
Copper
Cobre / Cuivre

EM ▲●■



47.21
Platinum
Platino / Platine

EM ▲



43.21
Bronze
Bronce / Bronze

EM ▲



63.24
Graphite
Grafito / Graphite

EM ▲●

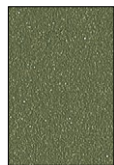

64.24
Silver green
Verde plateado / Vert argenté

EM ▲●



65.24
Silver blue
Azul plateado / Bleu argenté

EM ▲●

Earth



51.18
Sand
Arena / Sable

EM ▲●



57.21
Clay
Creta / Crète

EM ▲●



52.18
Moss
Musgo / Mousse

EM ▲●



66.24
Lichen
Liquen / Lichen

EM ▲■



67.24
Pink clay
Arcilla rosa / Argile rose

EM ▲●■



68.24
Sodalite
Sodalita / Sodalite

EM ▲



56.21
Ocean
Oceano / Océan

EM ▲

Surfaces / Superficies / Surfaces

EM Embossed / Gofrado / Gaufré

Use / Usos / Utilisations

- ▲ Tops / Encimeras / Plans
- Outdoor / Exteriores / Extérieur
- Food / Alimentario / Alimentaire

Glass essentials

**G01.23**
Black (RAL 9005)

Negro / Noir

ET ▲ ■

**G08.23**
Rose quartz

Rosa cuarzo / Quartz rose

ET ▲ ■

**G15.23**
Forest green (RAL 6007)

Verde bosque / Verte forêt

ET ▲ ■

**G02.23**
Anthracite (RAL 7021)

Antracita / Anthracite

ET ▲ ■

**G09.24**
Terracotta (RAL 8004)

Terracota / Terre cuite

ET ▲ ■

**G16.24**
Cement (RAL 7033)

Cemento / Ciment

ET ▲ ■

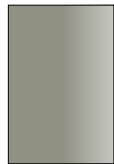
**G03.23**
Fantin grey

Fantin gris / Gris Fantin

ET ▲ ■

**G10.23**
Flame red (RAL 3000)

Rojo Fuego / Rouge feu

ET ▲ ■

**G17.24**
Slate (RAL 7031)

Pizarra / Ardoise

ET ▲ ■

**G04.23**
Light grey (RAL 7035)

Gris claro / Gris clair

ET ▲ ■

**G11.23**
Melon yellow (RAL 1028)

Amarillo melón / Jaune melon

ET ▲ ■

**G18.23**
Dusty blue (RAL 5014)

Azul polvoriento / Bleu poussiéreux

ET ▲ ■

**G05.23**
Cloud grey

Gris nube / Gris nuage

ET ▲ ■

**G12.23**
Zinc yellow (RAL 1018)

Amarillo zinc / Jaune de zinc

ET ▲ ■

**G19.23**
Gentian blue (RAL 5010)

Azul genciana / Bleu gentiane

ET ▲ ■

**G06.23**
White (RAL 9016)

Blanco / Blanc

ET ▲ ■

**G13.23**
Pastel green (RAL 6019)

Verde pastel / Vert pastel

ET ▲ ■

**G20.23**
Steel blue (RAL 5011)

Azul acero / Bleu acier

ET ▲ ■

**G07.23**
Milk white (RAL 9001)

Blanco leche / Blanc de lait

ET ▲ ■

**G14.23**
Sage green (RAL 6021)

Verde salvia / Vert sauge

ET ▲ ■

**G21.23**
Coffee brown (RAL 8019)

Marrón café / Marron café

ET ▲ ■

Glass design



G61.24
Pale gold
Oro claro / Or clair

ET ▲ ■



G51.23
Sand
Arena / Sable

ET ▲ ■



G62.24
Copper
Cobre / Cuivre

ET ▲ ■

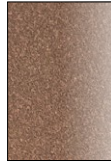

G57.23
Clay
Creta / Crète

ET ▲ ■



G47.23
Platinum
Platino / Platine

ET ▲ ■



G52.23
Moss
Musgo / Mousse

ET ▲ ■



G43.23
Bronze
Bronce / Bronze

ET ▲ ■



G66.24
Lichen
Liquen / Lichen

ET ▲ ■



G63.24
Graphite
Grafito / Graphite

ET ▲ ■



G67.24
Pink clay
Arcilla rosa / Argile rose

ET ▲ ■



G64.24
Silver green
Verde plateado / Vert argenté

ET ▲ ■



G68.24
Sodalite
Sodalita / Sodalite

ET ▲ ■



G65.24
Silver blue
Azul plateado / Bleu argenté

ET ▲ ■



G56.23
Ocean
Oceano / Océan

ET ▲ ■

Surfaces / Superficies / Surfaces

ET Etched / Mateado / Gravé

Use / Usos / Utilisations

- ▲ Tops / Encimeras / Plans
- Outdoor / Exteriores / Extérieur
- Food / Alimentario / Alimentaire

Stainless steel
Acero inoxidable
Acier inoxydable

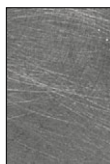

K1.18
Inox Vintage

Inox Vintage / Inox Vintage

HG ▲●■



K2.19
Inox Satin

Inox satin / Inox satin

HG ▲●■

Surfaces / Superficies / Surfaces

HG High Gloss / Alto brillo / Haute brillance

Use / Usos / Utilisations

- ▲ Tops / Encimeras / Plans
- Outdoor / Exteriores / Extérieur
- Food / Alimentario / Alimentaire

Technical information

Metal Non-toxic powder coating for interior use, with no heavy metals. Cured in an oven at 190 °C, following degreasing and phosphating. Guaranteed minimum thickness of 50 microns. Minimum resistance to salt spray of 200 hours (in accordance with the ASTM B117 standard). Some finishes are suitable for direct contact with food as required by Italian Law Decree D.M. 21/03/73 and subsequent updates. Requests for other RAL finishes can be considered. On some finishes, any partial discolouration following rubbing and/or abrasion has absolutely no effect on the technical, appearance/colour and chemical/physical characteristics of the product. This phenomenon tends to diminish over the useful life of the product and does not in any case present a health hazard to users.

Glass Extra-clear glass, with a thickness of 6 mm (0.24"), etched on the top, ground with a matt edge. Coated on the back with water-based paint in the 35 Fantin finishes.

AISI 304 stainless steel Kitchen top with a thickness of 4 mm (0.16") with Vintage (exclusive Barazza manual processing, making it quicker and easier to maintain) or satin finish.

Información técnica

Metal Recubrimiento en polvo atóxico para interiores, sin metales pesados, con paso en horno a 190 °C, previo tratamiento de desengrase y fosfatación. Espesor mínimo garantizado 50 micrones, resistencia mínima en niebla salina igual a 200 horas (norma ASTM B117). Algunos acabados son aptos para el contacto directo con alimentos, según lo previsto por el decreto italiano D.M. 21/03/73 y posteriores actualizaciones. Se pueden evaluar otros acabados RAL bajo pedido.

En algunos acabados, una decoloración parcial debida al roce y/o a la abrasión no afecta en absoluto a las características técnicas, de aspecto/color y químicas/físicas del producto. Este fenómeno tiende a disminuir a lo largo de la vida útil del producto y no representa en ningún caso un peligro para la salud de los usuarios.

Vidrio Vidrio extraclaro de 6 mm (0,24") de espesor, mateado al ácido en la parte superior, esmerilado con borde opaco. Pintado en la parte trasera con pintura al agua en los 35 acabados Fantin.

Acero inoxidable AISI 304 Encimera de cocina de 4 mm de espesor (0,16") con acabado vintage (producción manual exclusiva Barazza, cuyo mantenimiento es más simple y fácil) o satinado.

Informations techniques

Métal Revêtement en poudre non toxique pour l'intérieur sans métaux lourds, avec passage au four à 190 °C, après traitement de dégraissage et de phosphatation. Épaisseur minimale garantie de 50 microns. Résistance minimale au brouillard salin de 200 heures (norme ASTM B117). Certaines finitions sont adaptées au contact direct avec les aliments, comme l'exige l'arrêté ministériel italien du 21/03/73 et ses mises à jour ultérieures. Autres finitions RAL possibles sur demande.

Sur certaines finitions, une éventuelle décoloration partielle due au frottement et/ou à l'abrasion n'a absolument aucune incidence sur les caractéristiques techniques, d'aspect/couleur et chimiques/physiques du produit. Ce phénomène tend à s'atténuer au cours de la vie utile du produit et ne présente en aucun cas un danger pour la santé des utilisateurs.

Verre Verre extra-clair de 6 mm (0.24") d'épaisseur, décapé sur la face supérieure, bord meulé mat. Rétro-laqué avec peinture à l'eau dans les 35 finitions Fantin.

Acier inoxydable AISI 304 Plan de travail de cuisine de 4 mm (0.16") d'épaisseur avec finition Vintage (traitement manuel exclusif Barazza, pour un entretien plus facile et plus pratique) ou satinée.

Kitchens and workbenches with a visible support structure and inset doors and drawers, distinguishing visual features of the minimal design scheme.

Frame made of 35 x 35 mm (1.38" x 1.38") square tubes. Concealed levelling feet, laterally adjustable.

Top made of extra-clear glass, with a thickness of 6 mm (0.24"), etched on the top, ground with a matt edge. Coated on the back with water-based paint in the 35 Fantin finishes.

Top made of AISI 304 stainless steel filler panel with a thickness of 4 mm (0.16") with satin or Vintage finish (with exclusive Barazza manual processing). Also available with integrated sinks and equipment channels.

Top (only for workbenches) made of metal with a thickness of 3 mm (0.12") and a bottom fibreboard filler panel.

Doors inset in the frame, made of a double layer of bent sheet metal. Door thickness: 20 mm (0.79"). Metal handles with a coating in a colour to match the doors. Soft-close dampening hinges. 95° door opening.

Drawers with fronts inset in the frame, made of a double layer of bent sheet metal. Drawer front thickness: 20 mm (0.79"). Metal handles with a coating in a colour to match the drawer fronts. Drawers with Hettich runners and built-in stabilization and soft-close systems. Capacity: 40 kg (88.18 lb).

Sides and bases inset in the frame, made of bent sheet metal; filled sides.

Inside shelves made of bent sheet metal.

Optional backboards inset in the frame, made of metal.

Optional hobs – electric induction and gas – from Barazza, Electrolux, Elica.

Optional appliances with custom installation kit, from AEG, Barazza, Electrolux, Falmec.

Optional accessories – stainless steel sinks, roll-up draining mat, taps. Shelves, open compartments, panelling.

The kitchens are ready assembled (except for the tops).

Muebles de cocinas y bancos de trabajo con estructura de soporte visible, puertas y cajones insertados en el marco, características de un diseño minimalista.

Marco en tubo cuadrado de 35 x 35 mm (1.38" x 1.38"). Pies de nivelación ocultos, ajustables lateralmente.

Encimeras de vidrio de 6 mm (0.24") de espesor, grabado en la parte superior, rectificado con borde mate. Revestido en la parte posterior con pintura al agua en los 35 acabados Fantin.

Encimeras en acero inoxidable AISI 304 de 4 mm (0.16") de espesor con acabado satinado o vintage (producción manual exclusiva Barazza). Disponible también con fregaderos integrados y canales equipados.

Encimeras (solo para bancos de trabajo) en metal de 3 mm (0.12") de espesor, panel inferior con relleno en fibras de madera.

Puertas insertadas en el marco, en doble chapa plegada. Espesor de las puertas: 20 mm (0.79"). Manijas metálicas pintadas a juego con las puertas. Bisagras amortiguadoras de cierre suave. Apertura de 95°.

Cajones con frentes insertados en el marco de 20 mm (0.79") de espesor, en doble chapa plegada. Manijas metálicas pintadas a juego con los frentes de los cajones. Cajones con correderas Hettich, sistemas de estabilización y cierre suave integrados, con una capacidad de 40 kg (88.18 lb).

Laterales y bases insertadas en el marco, fabricadas en chapa plegada; con laterales rellenos.

Estantes internos en chapa plegada.

Fondos opcionales metálicos insertados en el marco.

Placas de cocción opcionales – inducción eléctrica y gas – de Barazza, Electrolux, Elica.

Electrodomésticos opcionales – con kit de instalación personalizado – de AEG, Barazza, Electrolux, Falmec.

Accesorios opcionales – fregaderos en acero inoxidable, rejilla enrollable multiusos, grifos. Estantes, compartimentos abiertos, paneles de pared.

Las cocinas se entregan montadas (sin encimeras).

Cuisines et les plans de travail avec le cadre porteur apparent et les portes et les tiroirs encastrés, qui deviennent des éléments au design minimaliste.

Cadre en tube carré de 35 x 35 mm (1.38" x 1.38"). Pieds de nivellement dissimulés, réglables latéralement.

Plateaux en verre de 6 mm (0.24") d'épaisseur, gravé sur le dessus, meulé avec un bord mat. Enduit au dos de peinture à l'eau dans les 35 finitions Fantin.

Plateaux en acier inoxydable AISI 304 de 4 mm (0.16") d'épaisseur avec finition satinée ou Vintage (traitement manuel exclusif Barazza). Également disponible avec éviers intégrés et canaux équipés.

Plateaux (uniquement pour les établis) en métal de 3 mm (0.12") d'épaisseur sur panneau de fibres de bois.

Portes encastrées à fleur du cadre, en double tôle pliée. Épaisseur des portes : 20 mm (0.79"). Poignées en métal peint dans le même coloris que les portes. Charnières amorties. Ouverture à 95°.

Tiroirs avec façades encastrées à fleur du cadre de 20 mm (0.79") d'épaisseur, en double tôle pliée. Poignées en métal peint dans le même coloris que les façades des tiroirs. Tiroirs avec glissières Hettich, systèmes de stabilisation et de fermeture en douceur intégrés pour une charge maximale de 40 kg (88.18 lb).

Côtés et fonds encastrés à fleur du cadre, en tôle pliée; côtés remplie.

Tablettes internes en tôle pliée.

Dos en option en métal encastrés à fleur du cadre.

Plaques de cuisson en option – induction électrique et gaz – de Barazza, Electrolux, Elica.

Appareils électroménagers en option avec kit personnalisé, d'AEG, Barazza, Electrolux, Falmec.

Accessoires en option – éviers en acier inoxydable, grille à usages multiples roll-up, robinets. Étagères, niches ouvertes, panneaux muraux.

Les cuisines sont livrées montées (sauf plateaux).

Disclaimer / Descargo de responsabilidad / Exclusion de responsabilité

Fantin Srl reserves the right to change the dimensions and features of the products contained in this technical data sheet at any time and without prior notice. The finishes illustrated are purely indicative as the accuracy tolerances of printing processes should be taken into account.

Fantin Srl se reserva el derecho de modificar en cualquier momento y sin previo aviso las dimensiones y ejecución de los productos presentes en esta ficha técnica. Los acabados mostrados son indicativos, ya que están sujetos a las tolerancias de los procesos de impresión.

Fantin Srl se réserve le droit de modifier à n'importe quel moment et sans préavis les dimensions et la fabrication des produits contenus dans cette fiche technique. Les finitions indiquées sont données à titre indicatif puisqu'elles sont sujettes aux tolérances des procédés d'impression.

Fantin Srl

via San Vito, 43
33080 - Bannia
di Fiume Veneto (PN)
Italia

t +39 0434 959 133
f +39 0434 560 037
fantin@fantin.com
www.fantin.com



UNI EN ISO 9001